

Product Specification

07/2018

Product TFT Display

Mode APT TFT 750C

Abbreviation 750C

Client

Customer

audit

Supplier

Tel

Email

1. Product Name

- ✧ TFT display
- ✧ Model : APT TFT 750C

2. Suppliers

- ✧
- ✧ Email :

3. Electrical Parameters

- ✧ 3.2inch IPS screen
- ✧ 24V/36V/48V/52V battery supply
- ✧ Rated operating current : 40mA
- ✧ Off leakage current < 1uA
- ✧ Max output current to controller : 100mA
- ✧ Operating temperature : -20~70°C, Storage temperature : -30~80°C

4. Dimensions & Material

- ✧ Product shell is ABS, transparent window is made with high strength Acrylic.
- ✧ Dimensions : host/L110mm*W68.2mm*H68mm



5. Features

- ✧ Suitable for low temperature, Max -20°C.

- ✧ High-contrast 3.2inch IPS colorful matrix screen.
- ✧ Ergonomic external button design, easy to operate.
- ✧ **Speed display:** AVG SPEED, MAX SPEED, SPEED (Real-time).
- ✧ **Kilometer / Mile:** Can be set according to customers' habits.
- ✧ **Smart battery indicator:** Provide a reliable battery indicator.
- ✧ **9-level Assist :** 3-level/5-level/9-level /UBE (6-level) optional.
- ✧ **Mileage indicator:** Odometer/ Trip distance/ Clock/ Riding time/ Range.
- ✧ **Power indicator:** real time power indicator, digital or analog.
- ✧ **Error code indicator.**
- ✧ **Software upgraded:** Software can be upgraded through UART.

6. TFT screen instructions

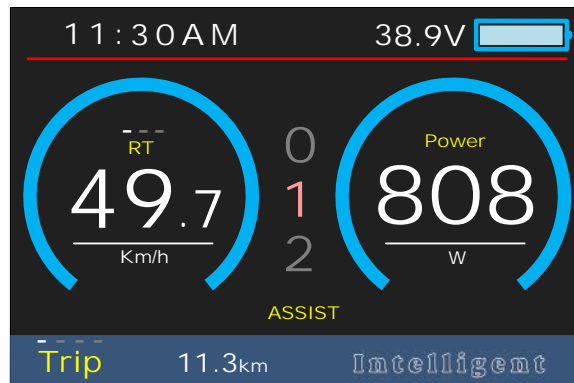

7. Functional Description

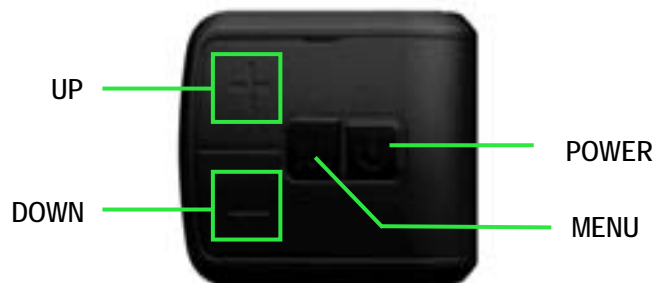

7.1 Power On/Off

Press and hold **Power** button for 1 second can turn on/off the display. The Display can automatically shut down when there is no operate & ride for X minutes (X could be

0~9) .

*If the display has been set password power on, you need to input the right password before start.

7.2 Assist level operating

Short press **UP/DOWN** button can change the assist level. Top assist level is 9, 0 for neutral. Level quantities can be adjusted according to the customer requirements.

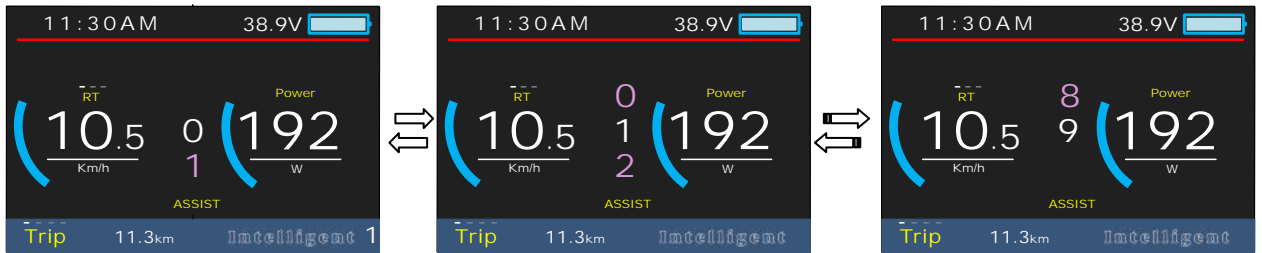

7.3 Speed mode switch

Short press **MENU** button can change the speed mode, **Speed->AVG Speed->MAX Speed**.

*If there is no operation for 5 seconds, display will return Speed (Real-Time) display automatically.

7.4 Mileage mode switch

Short press **POWER** button can change the mileage mode, Trip->ODO-> Time->Range.

7.5 Headlight/backlight On/Off

Press and hold **UP** button for 1 second can turn on/off the headlight, and the screen will switch to the corresponding mode.

*The motor does not work when the battery voltage is low, Display still can keep the headlight on for a while when E-bike is in riding.

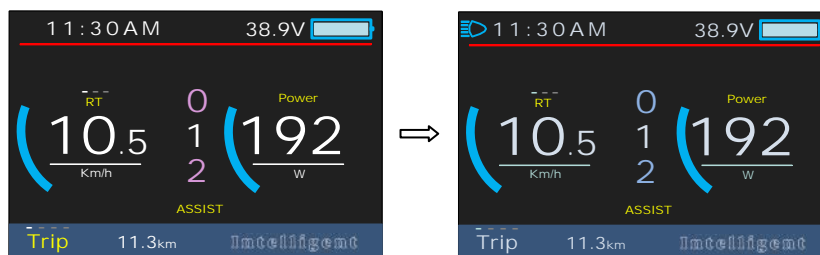

Daytime mode

night mode

7.6 Walking mode (6km)

Press and hold **DOWN** button for 2 second can get into walking mode, out of the mode when release the button.

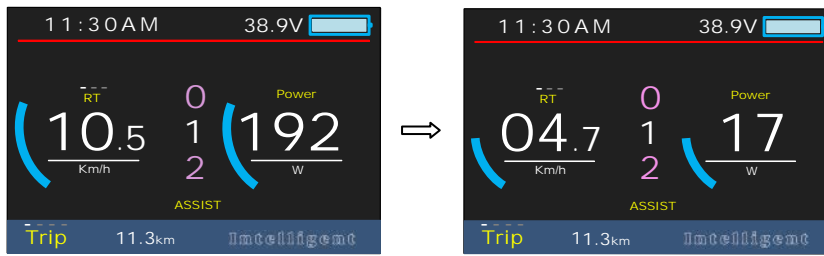

* This feature needs to be supported by controller.

7.7 Data cleanup

Press and hold **UP** & **DOWN** buttons together for 1 second can reset several temporary data, temporary data include **AVG Speed / MAX Speed / Trip / Time**.

* These temporary data can't be erased by power off.

8. Parameter setting

Double press **MENU** button (press interval less than 0.3 second) can get into setting menus, press **POWER** button to change **Display Setting / Basic setting**, press **UP/DOWN** buttons to change the parameter setting, press **MENU** button can switch to next item. Double press **MENU** button will exit from menu.

* Display will automatically quit menu when there is no operation for 30 seconds.

* For safety reasons, display can't get into MENU when riding.

* Display will quit MENU when start riding.

The order of parameters are as follow.

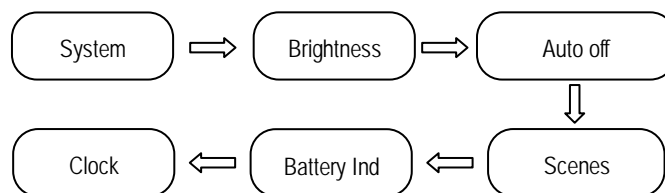

8.1 System : Press Up / Down button to switch between Metric / Imperial.

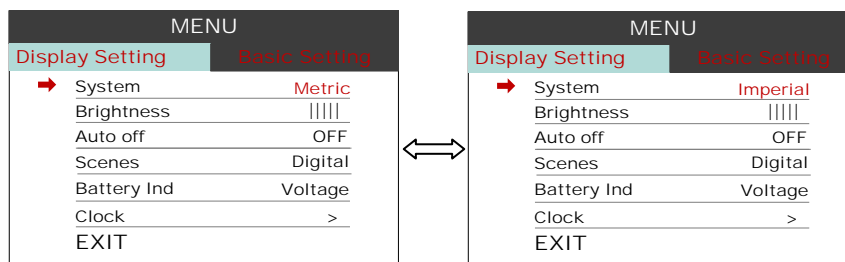

8.2 Brightness : Press Up / Down button to change the brightness of the backlight, | is

darkness, | is brightness. The daytime mode defaults to |||||, and the night mode defaults to |.

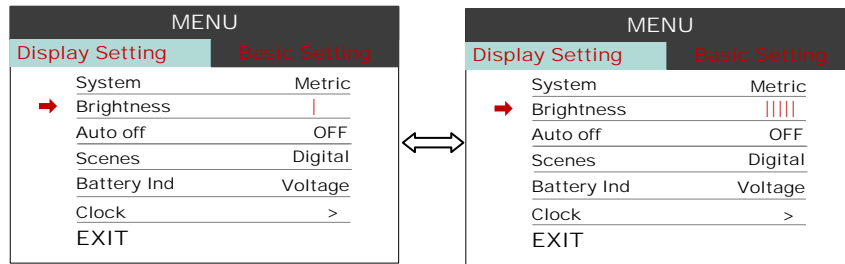

8.3 Auto off : Press UP/DOWN button to change the auto power off time, from 1 to 9 or **OFF**, the number represent time (minutes) to shutdown, default value is 5 minutes.

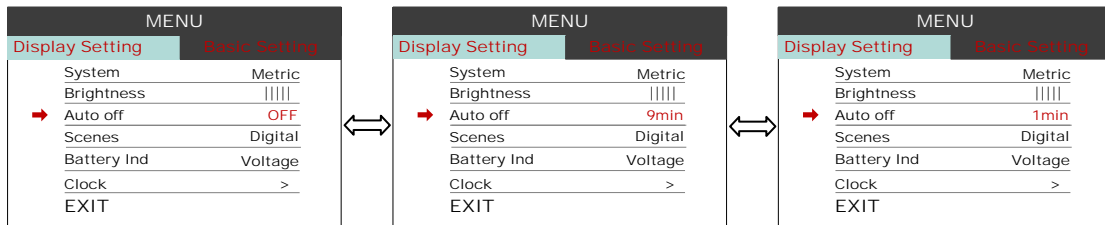

8.4 Scenes: Press UP/DOWN button to change the scenes, Digital / Analog.

*Display only support Analog scenes for now, Digital scenes will be supported for future.

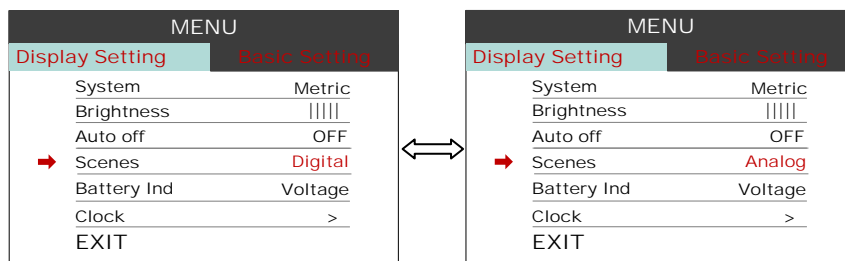

8.5 Battery Ind : Press UP/DOWN button to change the battery indicator, Voltage / Percentage / OFF.

*Accurate percentage needs communication with battery.

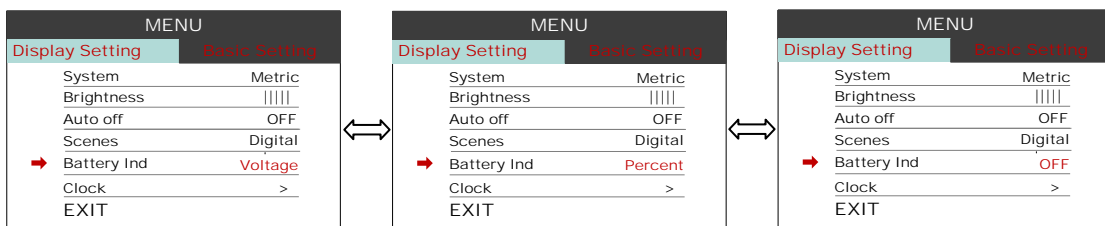

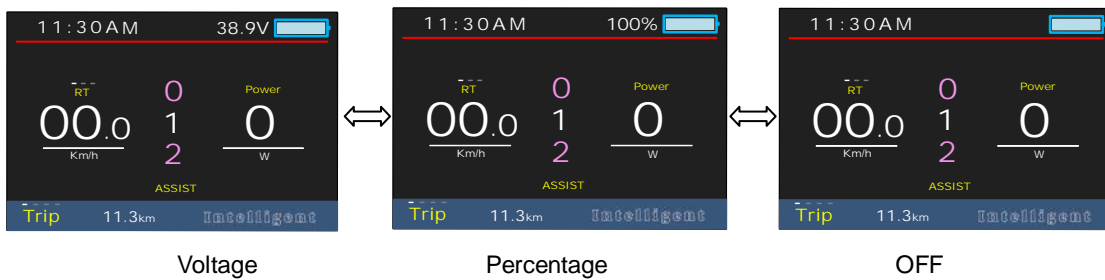

8.6 Clock : Clock setting, press **MENU** button get into the clock setting menu, press UP/DOWN button to set Year/Month/Day/Hour/Min/Sec.

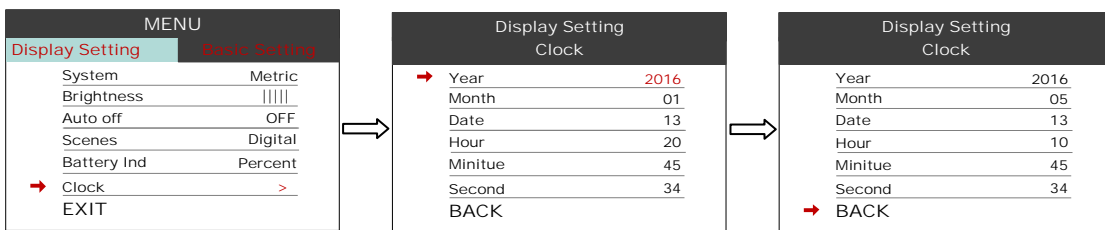

Basic Setting

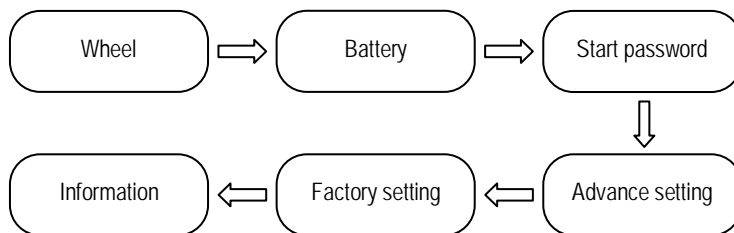

8.7 Wheel : Press UP/DOWN can change the wheel setting, optional wheel diameter is 12/14/16/18/20/22/24/26/27/27.5/28/29/30/31 inch, 51cm~255cm represent wheel circumference (this needs controller support).

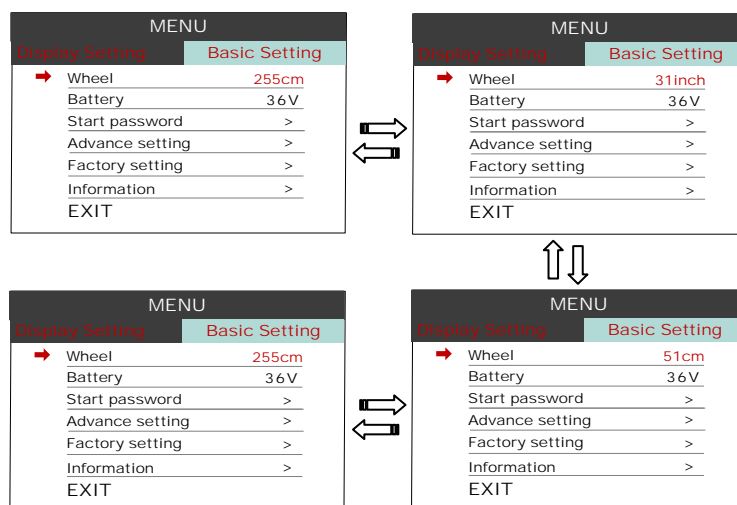

8.8 Battery : Press UP/DOWN will change battery voltage setting, optional value is

24V/36V/48V/UBE, UBE means user define value.

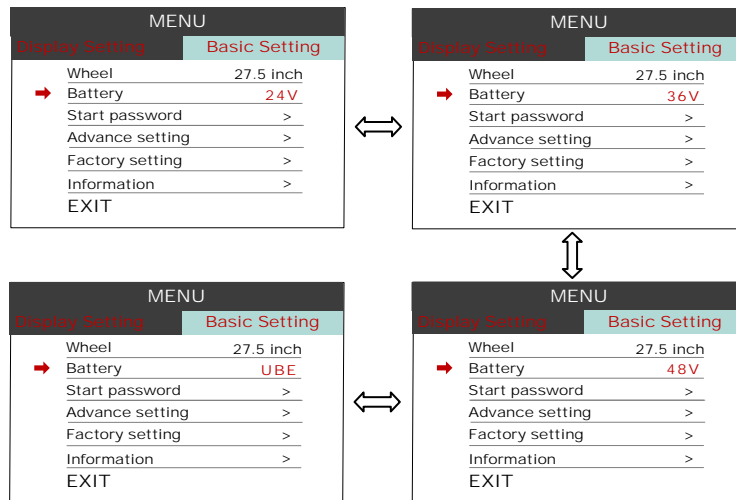

8.9 Start password : Press **MENU** button get into the password setting menu. If you had set Start input **ON**, you must input right password before power on, password is accorded to your setting.

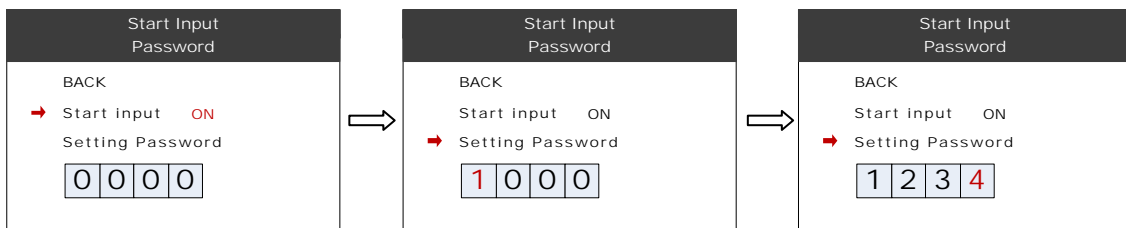
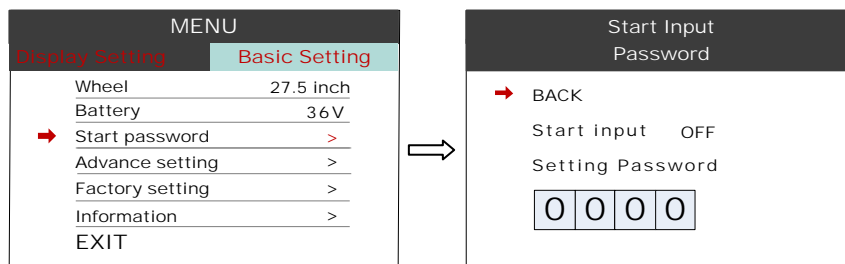

You need to input the right password before start with 30 seconds, display will power off automatically if the password was wrong three times.

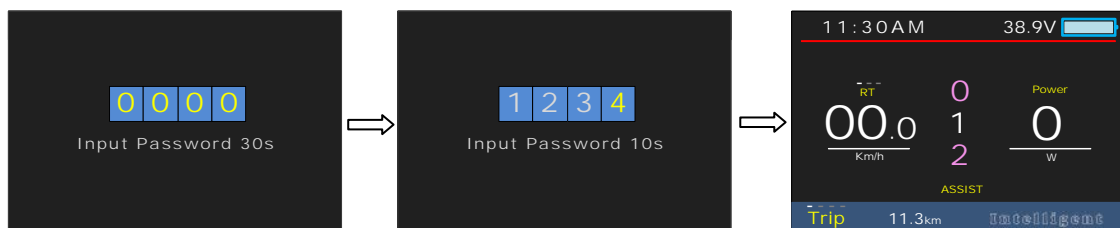

8.10 Advance setting: Press **MENU** button can get into the advance setting menu,

default password is '1919'.

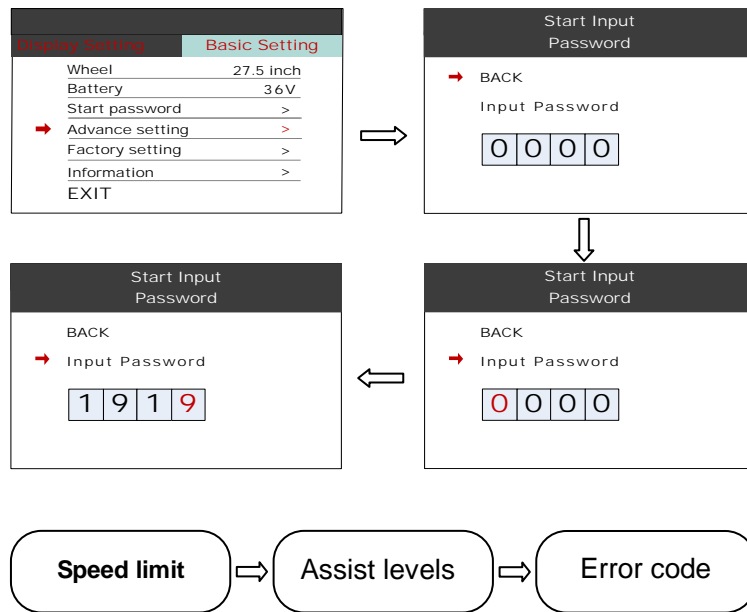

Note: Error code: Only display the error code that has occurred.

8.11 Speed limit: Press UP/DOWN will change speed limit, range 10km/h~60km/h and 99km/h. Unlimited speed is 99km/h. Default value is 25km/h.

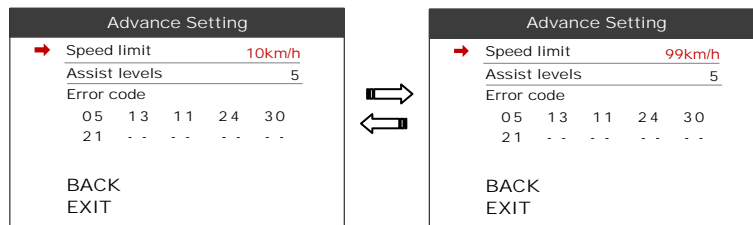

8.12 Assist levels: This parameter can customize assist levels, options are 3/5/9/UBE, UBE represent factory default settings.

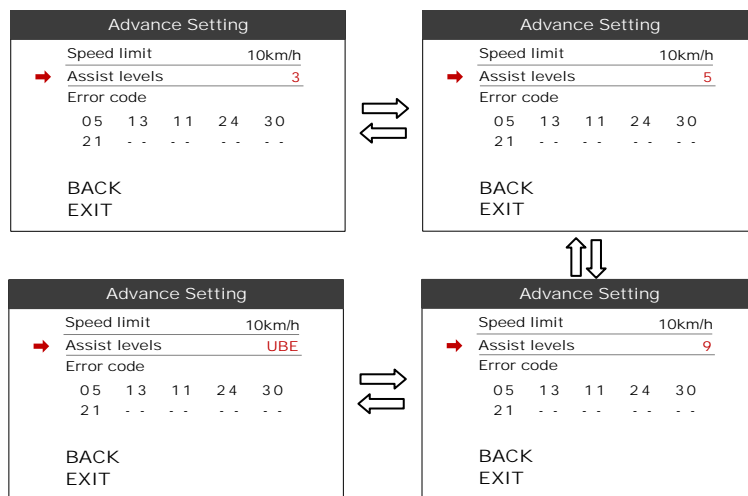

8.13 Factory setting: Press **MENU** button enter Restore Factory Settings item, set YES will restore all parameter to factory settings.

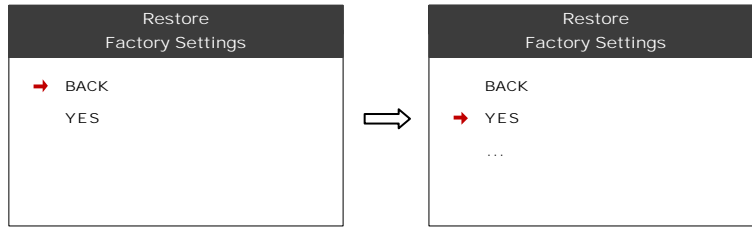

8.14 Information: Show information of the E-bike.

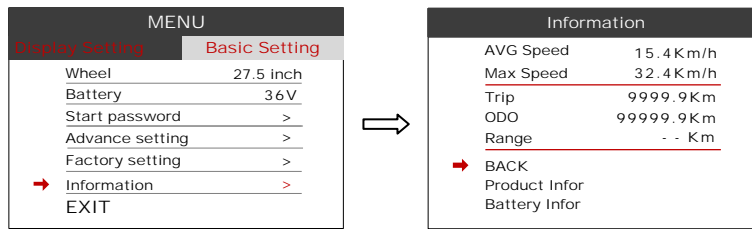

8.15 Product info: Get into this item can show hardware version software version...

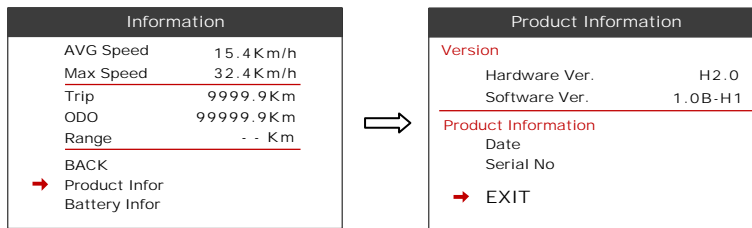

8.16 Battery info : Get into this item can show all information of battery, including Voltage, Capacity, Cycle times, Health, Temperature of battery, Remaining Capacity, Full Charge Capacity.

*These information needs to be supported by battery communication.

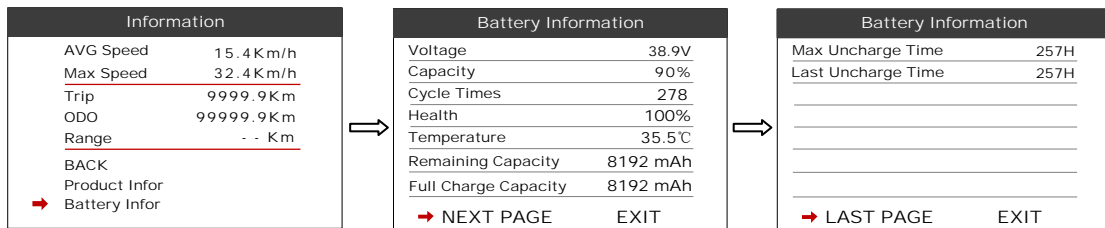

9. Error Code define

750C can show warning message,  icon shows on the screen, and show error code at the bottom of the screen, error code from 01~30, definition see the table below.

Error Code	Error description	Handle
0x04	Throttle turn back fault	Check turn to connect.
0x05	Throttle error	Check turn to connect.
0x06	Under voltage protection	Charge the battery
0x07	Overvoltage protection	Charge the battery
0x08	Hall error	Check the hall connection
0x09	three-phase power error	Check three-phase power line connection
0x10	The controller is overheated	Stop using 10 minutes to restart
0x11	Motor overheating	Stop using 10 minutes to restart
0x12	Sensor error	Check the sensor connection
0x13	battery temperature abnormality	Stop using 10 minutes to restart
0x14	Motor temperature sensor is abnormal	Check the sensor
0x15	Controller temperature sensor failure	Check the sensor
0x21	Speed sensor fault	Check the sensor
0x22	BMS Communication Error	Check the cable connection
0x23	Headlight error	Check the cable connection
0x24	Headlight sensor error	Check the cable connection
0x25	Torque signal error	Contact the supplier
0x26	Torque sensor speed error	Contact the supplier
0x30	Communication Error	Check the cable connection

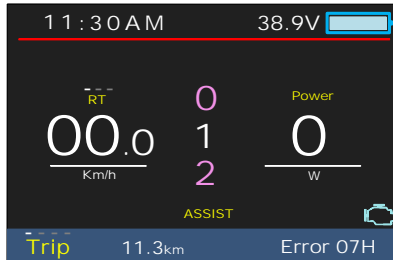
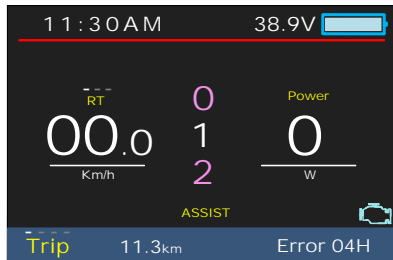

10. Assembly instructions

Please pay attention to the screw's torque value, damaged caused by excessive torque is not within the scope of the warranty.

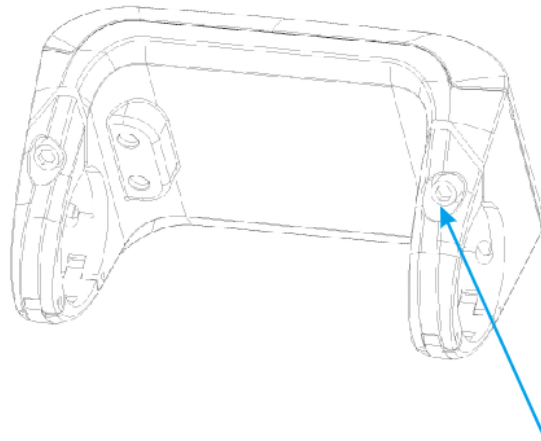

M4*10
STD=0.1N.M
MAX=0.2NM



M3*8
STD=0.25N.M
MAX=0.4N.M

Clamps suit for 3 size of handlebar, 31.8mm, 25.4mm, 22.2mm, there are transfer rings for 25.4mm and 22.2mm (marked with L or R), transfer ring must be assembled with the special directions, pay attention to the green arrow below.

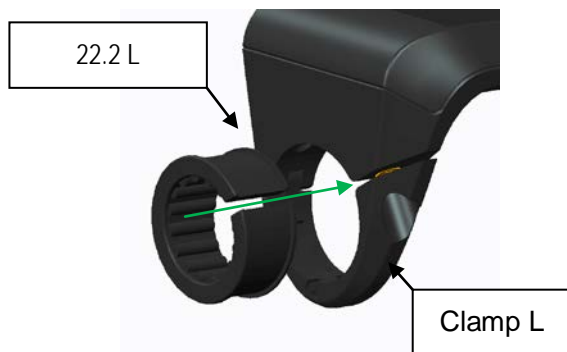

11. Connector descriptions

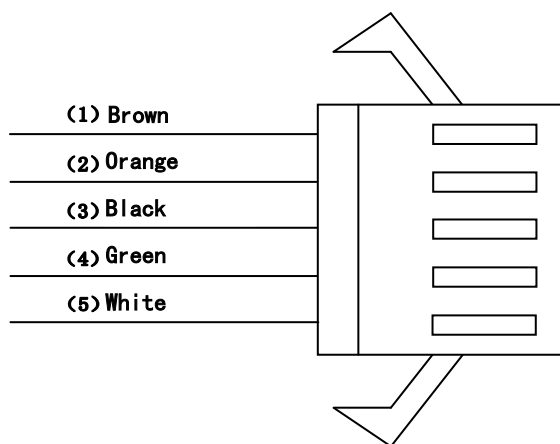

- 1、 Brown wire : Anode(24v/36v/48V/52V)
- 2、 Orange wire : Power cord to the controller
- 3、 Black wire : GND
- 4、 Green wire : RxD (controller -> display)
- 5、 White wire : TxD (display -> controller)

12. Assist level instructions

Assist level can be customized, the highest level is 9, common used assist level see the table below:

3 level	5 level	9 level	UBE (6level)	
0	0	0	0	No power assist
		1	1	
	1	2		
1		3	2	
	2	4		
2		5	3	
	3	6		
		7	4	
	4	8	5	
3	5	9	6	

13. Certification

CE / IP65 (water proof) / ROHS.